

UNIVERSITY HOSPITAL  
General Sir John Kotelawala Defence University

ජෙනරාල් ජිමත් ජේන් කොතලාවල ආරක්ෂක විශ්ව විද්‍යාලයීය රෝහල

ဂெனරාල් ජේර් ජොන් කොත්තලාවල පාඨාසායන පාලකවරයාගේ වෛද්‍යාලය

General Sir John Kotelawala Defence University Hospital

වේරහෙරා

බොරලෙස්ගමුව 10290

ශ්‍රී ලංකාව

වේරහෙරා

බොරලෙස්ගමුව 10290

இலங்கை

Werahera

Boralessgamuwa 10290

Sri Lanka

UHKDU/PRO/MED/103/2020

To Whom if any Concern

17<sup>th</sup> August 2020

**ADDENDUM TO TENDER INVITATION**

**NO:UHKDU/PRO/MED/103/2020**

**PURCHASE OF TEST TUBE RACKS FOR BLOOD BANK AT UNIVERSITY HOSPITAL**

Following mentioned fresh specifications included at as Annex 'B' of Tender document.

  
NVLK Weragoda  
Commander (S)  
Procurement Manager - UHKDU  
For Medical Procurement Officer - UHKDU

08  
02

Large size test tube rack

16 x 10 Holes

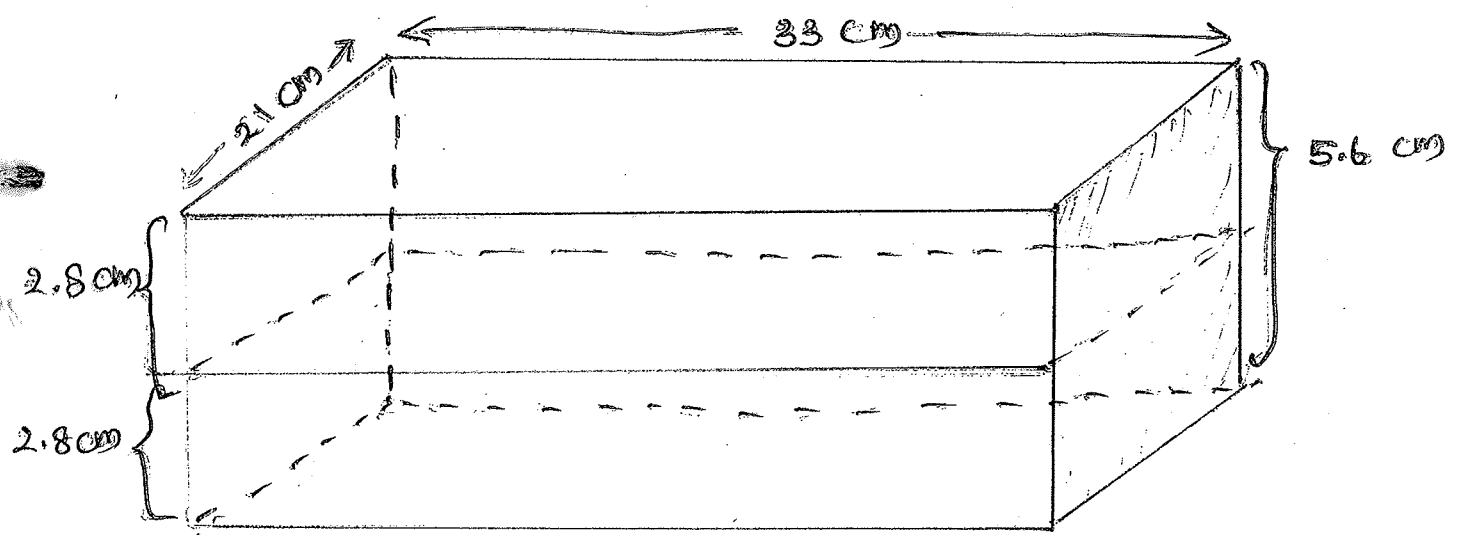
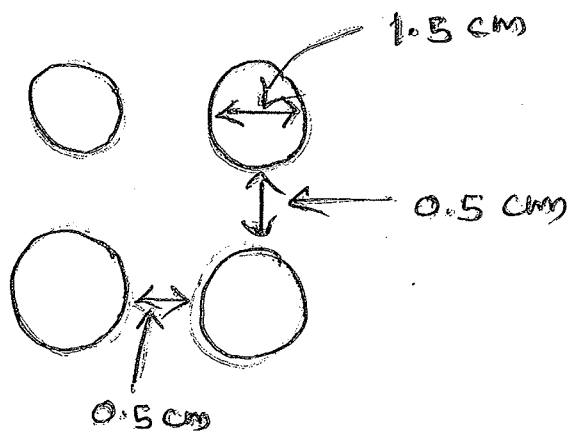
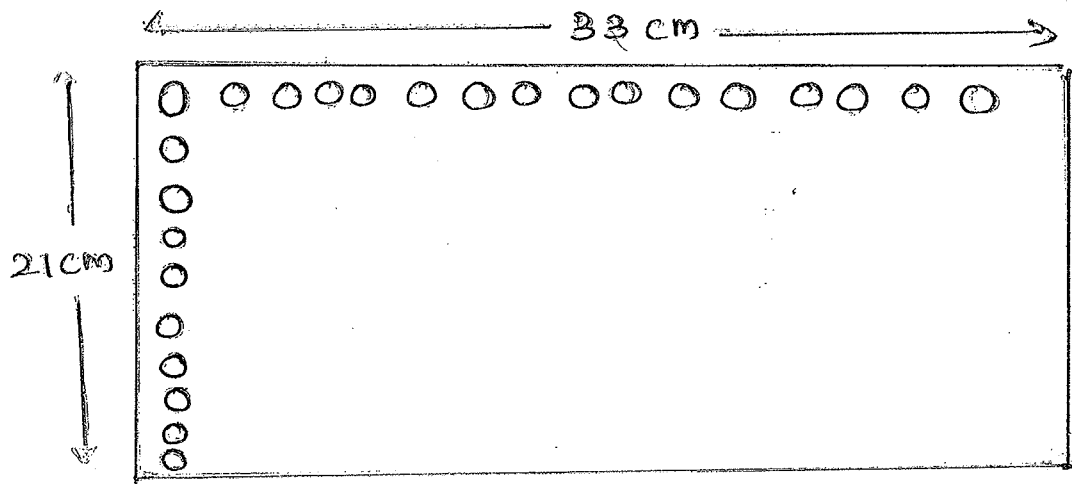

Amount

Large size test tube rack - 06

Dr. TRILICIA WITHANAWA  
 MBBS, Diploma  
 (Transfusion Medicine & Transfusion Med)  
 Senior Lecturer in Pathology & Transfusion Physician  
 General Sir John Kotelawala Defence University  
 Battaramulla, Sri Lanka  
 SLMC: 18026

# Medium Size test tube Rack

10x5 Holes

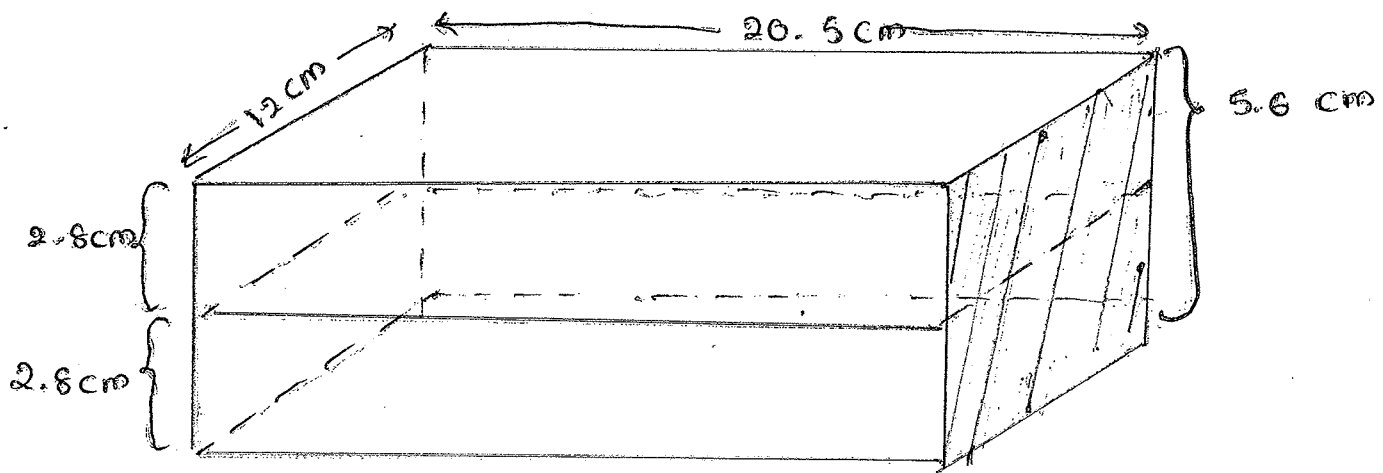
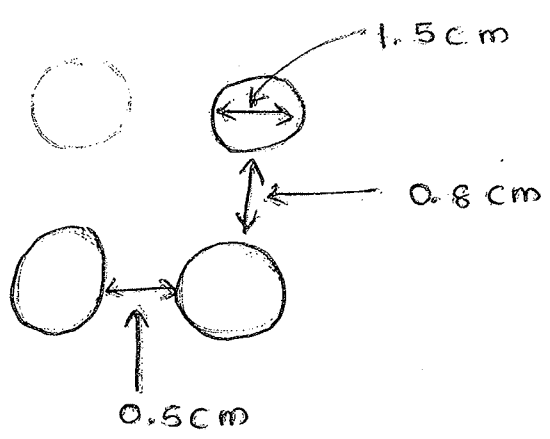
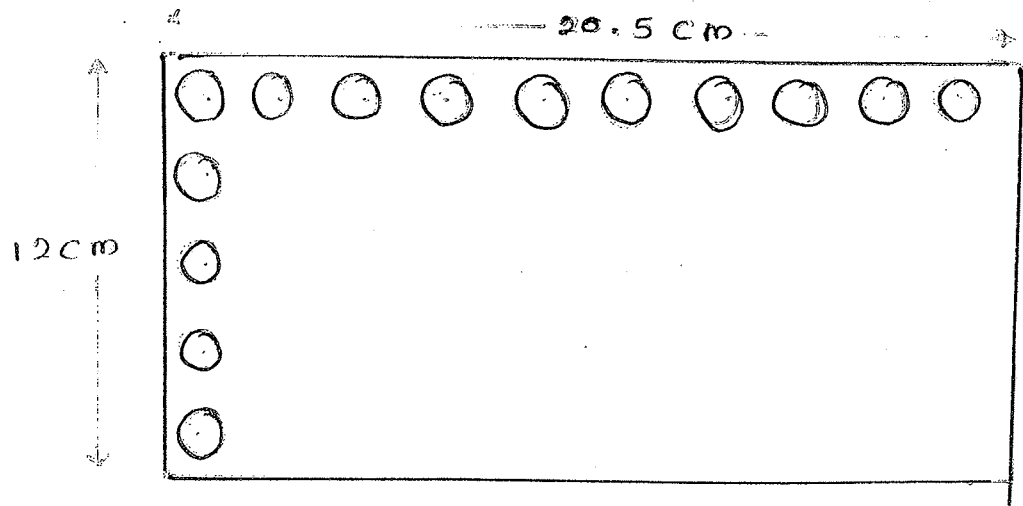

- Medium Size test tube rack Amount 08



2) Small size test tube rack with handles

12 x 3 Holes

02

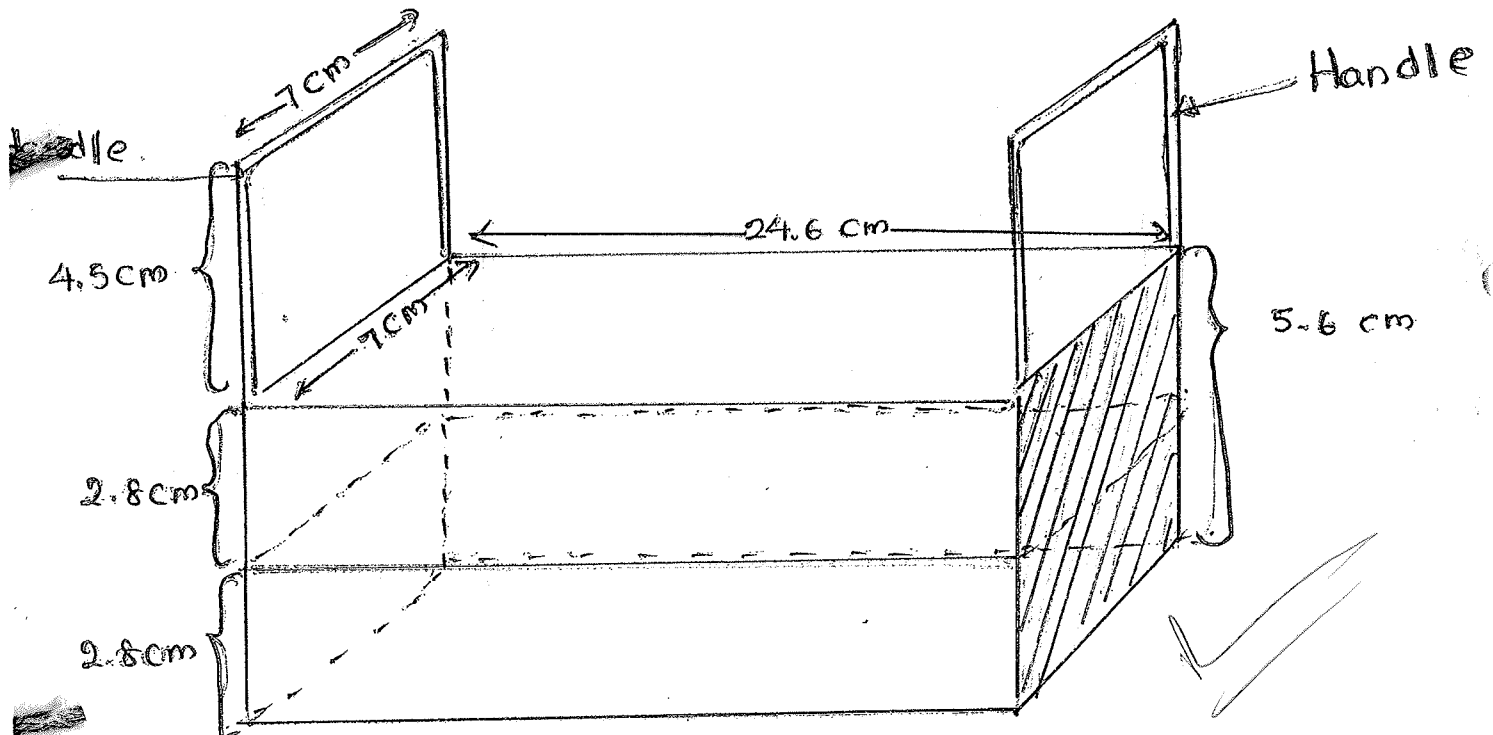
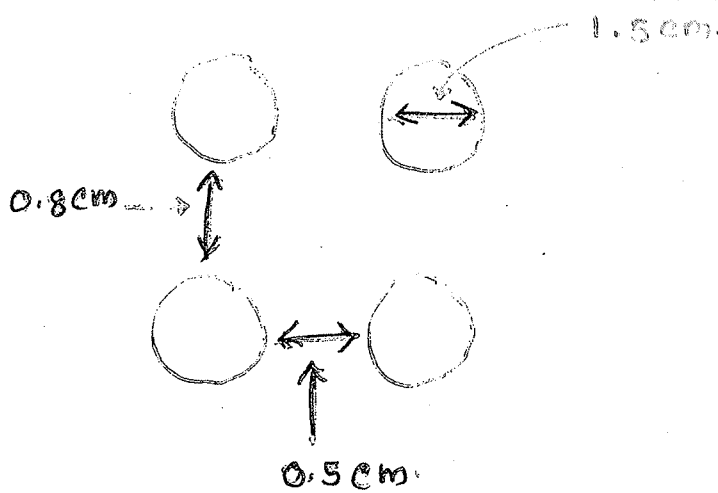
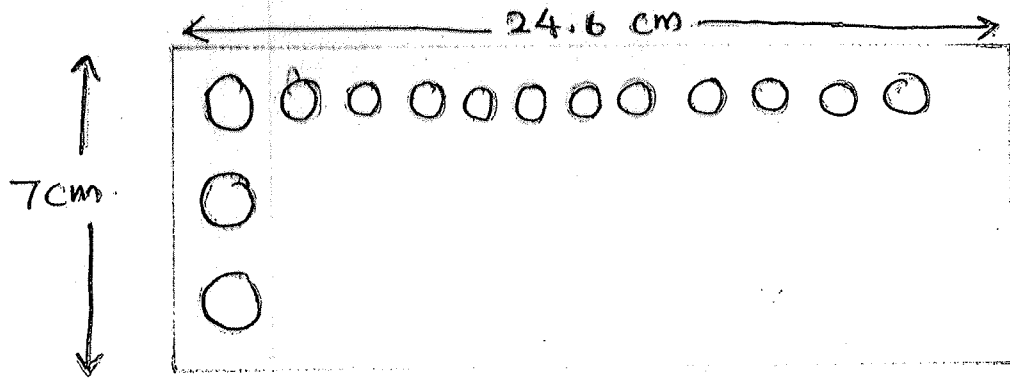

- Small size test tube rack with Handle -