

Tender No:

KDU/PRO/CAP/ 49/2021



General Sir John Kotelawala Defence University,
Kandawala Estate, Ratmalana,
Sri Lanka.
T: Phone: 2632028 , 2622995
Fax : 2622504, 2623599
Web: www.kdu.lk

04 / 03 / 2022

INVITATION TO BID AND GENERAL CONDITIONS OF TENDER

1. The Vice Chancellor of the General Sir John Kotelawala Defence University, as the Chairman, Department Procurement Committee Invites Bid/s from prospective Bidders for supply of **item/s listed in the schedule in Annex "A". The relevant specifications of the item/s are indicated in Annex "B".**

2. **CLOSING DATE & TIME.** The tender will close at 1000 hrs. on 29/ 03 /2022. Any Bid submitted after the closing time of the tender will be rejected & unopened such bids will be returned to the bidder.

3. **VALIDITY OF BID.** The bid submitted under this tender **must be valid for a period of 120 days from the date of closing of tender.**

4. **BID BOND / GUARANTEE.**

(a) If the quoted bid value exceeds Rs: 2,000,000.00, such Bids should be accompanied with 1% of Bid Value an "on demand" and "unconditional" Bid Bond/Guarantee for a sum of **Rs:** in the format given in Annex "C" through a recognized local Bank or Insurance Company registered in Sri Lanka which is authorized by the Insurance Board of Sri Lanka to issue such Bid Guarantees. All Bid Bond/Guarantees should be valid for at least 30 days more than the validity period of bids, ie, for 150 days from the date of Bid opening. **Cheques will not be accepted as Bid Guarantee.**

(b) Submission of insufficient Bid Bond/Guarantee value or period will be considered as a "**major deviation**" and such offer will not be considered for further procurement action and will be rejected.

5. **VALUE ADDED TAX.** The Bidders who bid for locally delivered items must have the VAT registration. The VAT portion must be shown separately in the price schedule in Annex "A" and VAT registration number must be indicated. If the quoted item is exempted from VAT or Bidding Company is not liable for VAT, reference number and date of relevant Act number/Gazette notification/a certificate (as applicable) **issued for the current financial year** from the Commissioner General of Inland Revenue to that effect should be submitted along with the Bid.

6. **BID SUBMISSION.** The **bidder must duly sign at the last page (before Annexes) of this document** indicating the name of the signatory and the name of the company & place the company common seal to confirm the acceptance of tender conditions. **The Bid/s that do not include authorized signature will be rejected.** The Bid/s duly signed by the bidder enclosed and sealed in an appropriate cover addressed to the following address should be sent by registered post or could be deposited in the **appropriate tender box placed at General Sir John Kotelawala Defence University, Kandawala Estate, Ratmalana** (at the Main Entrance of General Sir John Kotelawala Defence University) on or before the time & date specified for the closing of tender. **The tender reference number, date & time of closing tender should be indicated & underlined at the top left corner of the envelop.**

Tender Ref No
Closing Date & Time

The Chairman,
Department Procurement Committee,
General Sir John Kotelawala Defence University,
Kandawala Estate, Ratmalana,
Sri Lanka.

7. The Bid/s must be submitted in the attached schedule of prices in Annex "A" as applicable. However, bidders could use similar formats prepared with their own letter heads with all the details mentioned therein and submit in **three copies along with duly signed copy of a General Conditions of tender.** The Bid/s must contain **Technical Literature, Pamphlets, Drawings and Quality Standard Certificate etc** necessary to determine characteristics of items offered and in case of Machinery/Vehicles & Equipment, servicing and workshop data/after sales service, back up facilities or any other facilities provided by the supplier.

8. **SUBMISSION OF SAMPLES/PAYMENT OF TESTING CHARGES.**

When it is required to submit samples, **every offer** must be accompanied with pre - marked samples. The marking of samples **indicating the Bidder & Offer number** must be done and the samples must be handed over to the officer at same place where tender box is placed **on or before the closing date & time of the Bid.** Samples submitted after closing time of the Bid will be rejected. The documents such as Air Way Bills etc, will not be accepted in place of samples. When the testing charges are required to be paid, bidders shall pay testing charges separately **for all offers** indicated in their bid/s.

(1) **Samples.** Please submit samples.

(2) **Testing Charges.** A sum of Rs. **per offer** must be paid to the Bursar of KDU, prior to the submission of bid and a copy of the receipt must be annexed to the bid. It is the responsibility of bidder to inform the Cashier of the Account Office to note the tender number on the receipt issued for such payments.

8. **BID OPENING.** All duly received bids **will be opened immediately after the scheduled closing time of Bids at the same venue.** Bidders or their accredited agents could be present at the time of opening of bids.

9. **PRICES.**

For locally delivered items (including locally manufactured items & foreign items imported by the bidders) price must be quoted in Sri Lankan Rupees, inclusive of all charges for delivery of items to General Sir John Kotelawala Defence University Ratmalana, Faculty of Allied Health Science (FAHS) Werahera and University Hospital Werahera or Southern Campus Sooriyawewa. **Unit price, VAT and Total price should be clearly indicated in schedule in Annex "A".** Other than VAT, all other type of taxes (eg : NBT, BTT, etc.) should not be indicated separately and should be included in unit price.

10. **RESTRICTED TENDERS.**

Invitation to Bids are circulated among the registered suppliers with Ministry of Defence (MOD), only bids submitted by registered suppliers will be allowed for consideration. However, Chairman, Department Procurement Committee reserves the right to invite the bids from multiple combinations of Procurement Methods as stipulated in Chapter III of the Government Procurement Guideline, 2006 to ensure highest competitiveness.

11. **PERFORMANCE BOND/GUARANTEE.**

A successful bidder shall furnish a Performance Bond/Guarantee in the form of "On Demand" & "Unconditional" Bank/Insurance Guarantee for a sum equivalent to 10% of the contract value for every contract that exceeds Rs. 2,000,000.00 or equivalent amount in foreign currency through a recognized Commercial Bank registered in Sri Lanka or through an Insurance Company authorized by the Insurance Board of Sri Lanka to issue such Performance Guarantee for this purpose, **within two weeks from the date of notification of award.** The proceeds of the Performance Bond/Guarantee shall be payable to the Vice Chancellor of the General Sir John Kotelawala Defence University as compensation for any loss resulting from the supplier's failure to complete his performance obligations under the contract. If the contracted supplier fails to deliver the items on time or fails to complete the works as per the agreed contract, **THE TOTAL VALUE OF THE PERFORMANCE BOND/GUARANTEE** will be forfeited. If only partial delivery is made during the agreed contract period, the corresponding value percentage of undelivered quantity from the Performance Bond/Guarantee will be forfeited.

12. **SIGNING OF CONTRACT.**

The notification of award will be transmitted to the successful bidder by post, by fax or e-mail. This notification constitutes the formation of the contract. The successful bidder should submit his written acceptance for the award and performance bond / guarantee (For awards over Rs. 500,000.00 without VAT) within 14 days of receipt of such notification. Upon acceptance of the award and furnishing of the Performance Bond/Guarantee, the successful bidder will have to enter into a formal contract with the Vice Chancellor of the General Sir John Kotelawala Defence University by signing the Contract.

13. **DELIVERY.**

Preference will be given for early delivery. In case of bulk supplies for locally manufactured items, the delivery of **total quantity must be completed within 120 days of signing of contract,** unless mutually agreed for extended delivery period with General Sir John Kotelawala Defence University. **The bidder/s must indicate the proposed delivery schedule in Annex "D".** In the event of placing a purchase order with the successful bidder, the total quantity so ordered must be supplied as one consignment unless part deliveries are agreed upon in the contract. The deliveries not made as per agreed delivery schedule will be considered as bad performances by the suppliers and **no extended delivery period will be authorized.** Under extreme unavoidable conditions too, the Chairman, Department Procurement Committee (Vice Chancellor of the General Sir John Kotelawala Defence University) reserves the right to grant or refuse delivery period extensions only within the current financial year with or without liquidated claim for delayed deliveries and that decision will be final.

14. **LIQUIDATED DAMAGES.**

In case of delivery period extensions requested by the successful bidder, a sum equivalent to 1% of the total value of the delayed supply per delay of one week or part thereof may be deducted from the payment due to the supplier from the General Sir John Kotelawala Defence University as liquidated damages up to the maximum limit of 12% of the total value of delayed supplies.

15. **PAYMENT TERMS FOR LOCALLY DELIVERED ITEMS.**

Payment will be made after acceptance of items which should be subjected to a pre-acceptance inspection/testing by General Sir John Kotelawala Defence University authorities. The delivery made to the General Sir John Kotelawala Defence University should not be considered as quantities taken over by General Sir John Kotelawala Defence University until items are properly accepted after pre-acceptance inspection. Any item that does not conform to the specifications or already approved sample will be rejected & it is the responsibility of the supplier to remove them from General Sir John Kotelawala Defence University stores/premises within 07 working days of such intimation (either verbal or written) at his own cost and replace them with items conforming to specification within one month of such rejection. The bidder shall allow approximately 60-90 days' period of credit from the date of acceptance of items for Account Office, General Sir John Kotelawala Defence University to obtain liquid cash from General Treasury & release the payment.

16. **RIGHTS OF THE PROCUREMENT COMMITTEE.**

The Department Procurement Committee reserve the right to accept or reject whole or part of this tender and their decision will be final. The successful bidders will be notified. Information with regard to rejected or unsuccessful bids will not be communicated.

Thanking You,
Yours faithfully,

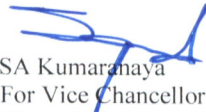
SA Kumaranaya
For Vice Chancellor
General Sir John Kotelawala Defence University

I/We agree to abide by the conditions of tender and undertake to supply the items as per delivery schedule mentioned in the contract, in the event of an order been placed with me/my firm/company as a result of this tender.

..... Signature

..... Name of Signatory

.....Name of the Company/Bidder

Date :-

Company seal

SCHEDULE OF PRICES FOR LOCALLY DELIVERED ITEMS

S/N	ITEMS	DENO	QTY	PRICE EACH SLRS	TOTAL PRICE SLRS
	<u>PURCHASE OF LABORATORY FURNITURE ITEM FOR DEPT. OF CIVIL ENGINEERING</u>				
01	Executive Chair	Nos	07		
02	Low Back Chair	Nos	15		
03	Visitors chair	Nos	04		
04	Computer chair	Nos	10		
05	Executive table	Nos	07		
06	Clerical table	Nos	09		
07	Computer table	Nos	10		
08	Cupboard steel	Nos	01		
09	Filling cupboard	Nos	06		
10	Mini Cupboard	Nos	01		
11	Two Door melamine cupboard	Nos	06		
12	8' steel rack	Nos	01		
13	6' steel rack	Nos	04		
14	Map drawer cabinet	Nos	01		
15	Pigeon hall rack	Nos	01		
	<i>As Per the Attached Specifications</i>				
	TOTAL				
	DISCOUNT				
	TOTAL(AFTER DISCOUNT)				
	VAT %				
	GRAND TOTAL				

(A) OTHER DETAILS

- (i) DELIVERY PERIOD -
- (ii) MAKE & MODEL -
- (iii) VALIDITY PERIOD -
- (iv) WARRANTY PERIOD -
- (v) PAYMENT TERMS - CREDIT
- (vi) COUNTRY OF ORIGIN -
- (vii) DISCOUNT IF ANY -
- (viii) ANY OTHER TAXES -

(B) VAT DETAILS

- VALUE ADDED TAX PERMANENT REGISTRATION CERTIFICATE / VAT EXEMPTION LETTER ISSUED BY DEPARTMENT OF INLAND REVENUE TO BE ATTACHED

(C) PLACE OF DELIVERY

- ITEMS TO BE DELIVERED TO THE "GENERAL SIR JOHN KOTELAWALA DEFENCE UNIVERSITY, KANDAWALA STATE, RATMALANA ALONG WITH THE COPY OF ORDER AND RELEVANT INVOICE.

(D) Any queries / information with regard to this procurement / tender could be obtained from Officer Commanding Logistics Services office at General Sir John Kotelawala Defence University through e-mail oels@kdu.ac.lk and by telephone number 0112622504 during working hours.

NOTE: UNIT PRICE AND TOTAL PRICE ARE TO BE INDICATED CLEARLY IN THE TENDER, IF NOT QUOTATION WILL BE REJECTED.

SUPPLIER NAME -
ADDRESS -
CONTACT NUMBER -
E MAIL ADDRESS -







(E) Bid Reference: KDU/PRO/CAP/ 49/2021

.....
DATE

Department of Civil Engineering

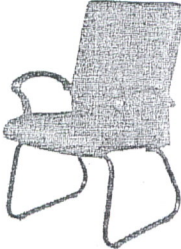
Specifications of Chairs

Item	Specifications	Qty	Image
1.Executive Chair	High Back Chair with Leatherette upholstery Steel base	07	
2.Normal Chair	Low Back Chair with Leatherette upholstery Normal Base	15	
3.Visitors Chairs	Cantilever Base Visitor Chair with Leatherette upholstery Normal Base	04	
4.Computer Chair	With arm Quality fabric upholstery Normal Base	10	



RK

19/03/21

Eng.(Dr.) R.P. Kumanyake
PhD(China), MBA(Colombo) BSc Eng.(Moratuwa), AMIE(SL)
Senior Lecturer
Head, Department of Civil Engineering
General Sir John Kotelawala Defence University
Ratmalana, Sri Lanka

Department of Civil Engineering

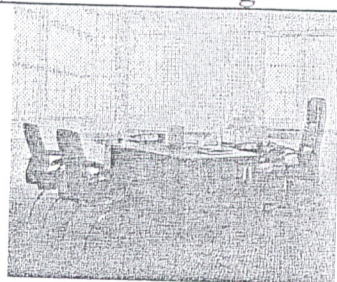
Specification of Tables

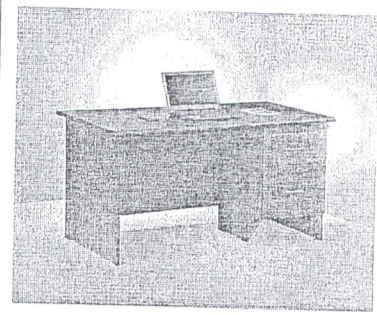

Item	Specifications	Qty	Image
5.Executive Table	Size: 1300Lx750Wx750H	07	
	Mobile pedestal with 3 drawer		
	Melamine Finish		
6.Computer Table	Size: 800L x400Wx770H	10	
	Melamine Finish		
	With wheels		
7.Clerical Chair	Size: 1200Lx700Wx750H	09	
	With drawers		
	Melamine Finish		

R/K

Eng(Dr.) RP Kumanayake AMIE(SL)
PhD(China), MBA Eng(Dr.) RP Kumanayake
PhD(China), MBA(Colombo) BSc Eng.(Moratuwa), AMIE(SL)
Senior Lecturer
Gen. Head, Department of Civil Engineering
General Sir John Kotelawala Defence University
Ratmalana, Sri Lanka

Department of Civil Engineering

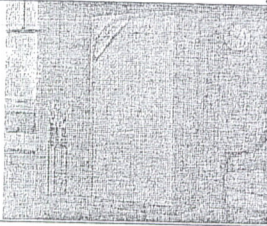
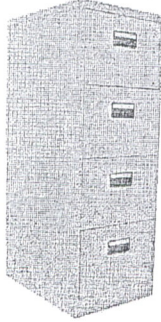
Specifications of Cupboard

Item	Specifications	Qty	Image
g. Cupboard steel	Cupboard Size: 800x400x1800 Steel Finish	01	
q. Filling Cupboard	04 Drawers Material – Powder Coated steel Length – 18" (inches) Width – 25" (inches) Height – 53" (inches)	06	
10 Mini cupboard	Cupboard Size: 800x400x1250 2 doors Melamine Finish	01	
11 Two Door cupboard	Cupboard Size: 800x400x1800 2 doors Melamine Finish	06	

RK

Department of Civil Engineering

Specifications of Steel Racks

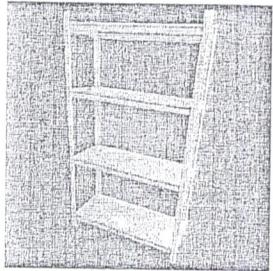
Item	Specifications	Qty	Image
12,13 Steel Racks	Height 6 feet	04	
	Height 8 feet	01	

Eng(Dr.) RP Kumanayake
PhD(China), MBA(Colombo) BSc Eng.(Moratuwa), AMIE(SL)
Senior Lecturer
Head, Department of Civil Engineering
General Sir John Kotelawala Defence University
Ratmalana, Sri Lanka

14. Specification of Map Drawer Cabinet

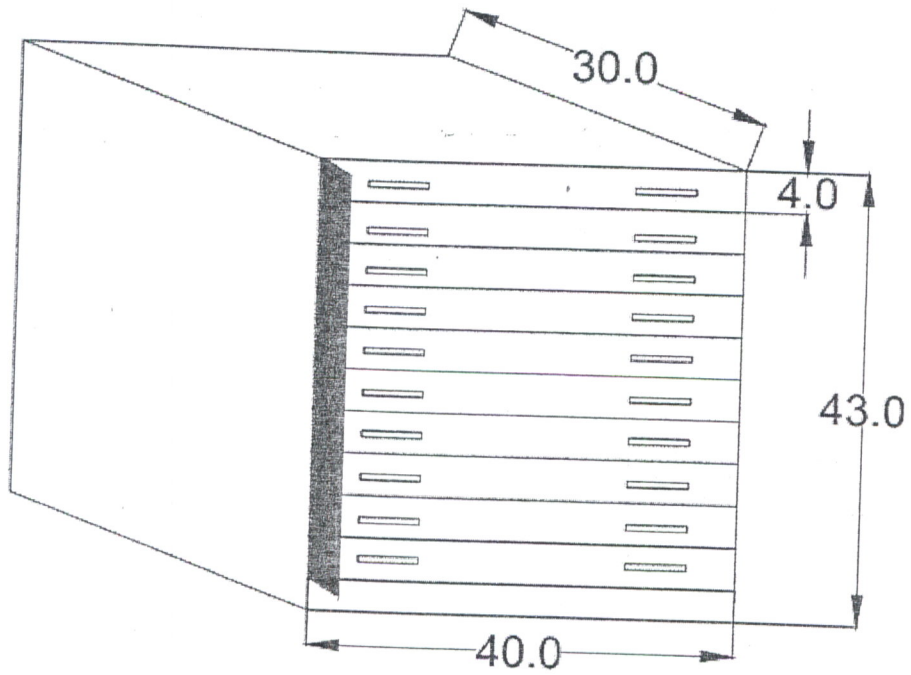
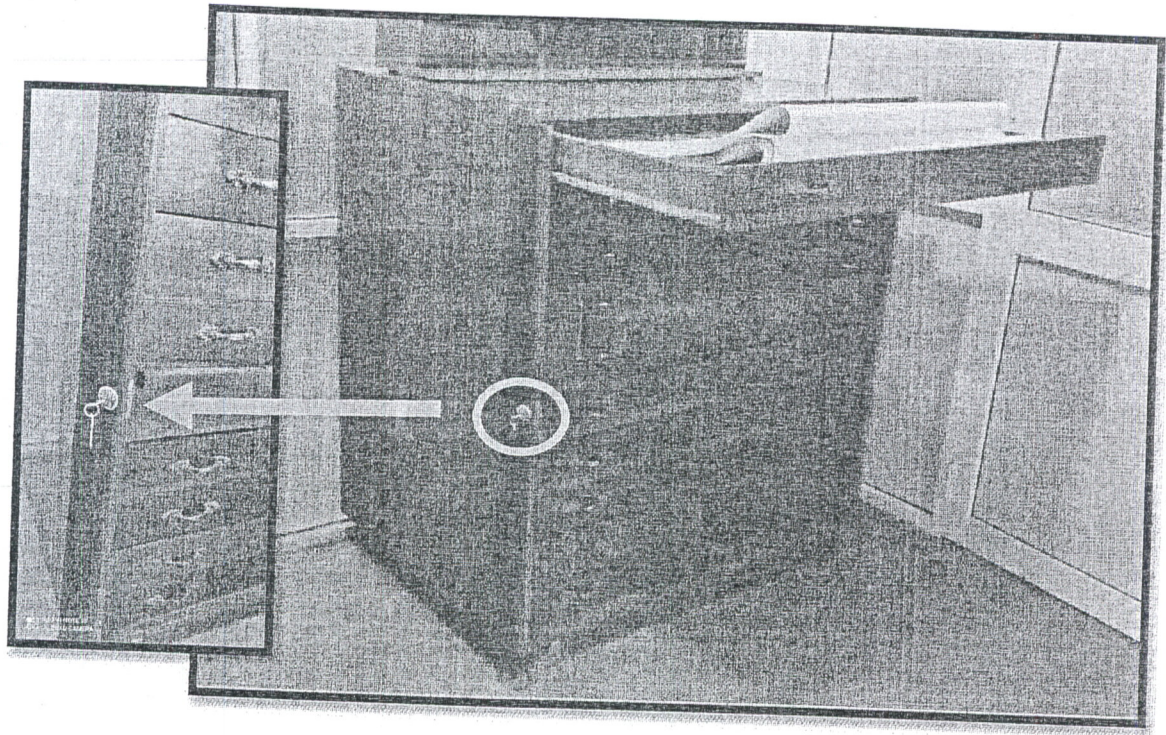

RK

Eng.(Dr.) RP Kumanayake
PhD(China), MBA(Colombo) BSc Eng.(Moratuwa), AMIE(SL)
Senior Lecturer
Head, Department of Civil Engineering
General Sir John Kotelawala Defence University
Ratmalana, Sri Lanka

Map Drawer Cabinet Contd.

All the units are in inches

Cabinet size : 42' x 30' x 43'

Drawer size : 42' x 30' x 4'

10 drawers

Material: Pre-Laminated MDF Board

Color: Teak brown

Thickness: 11 mm (or 0.5 inches)

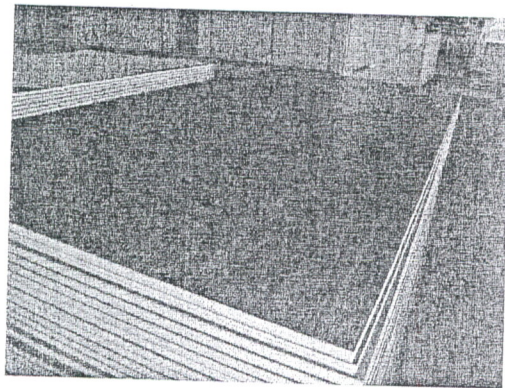
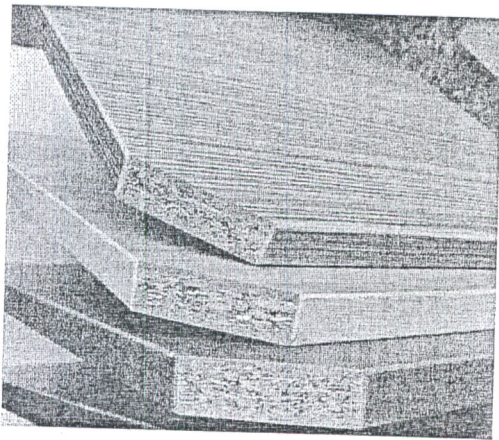

RIC

15. Specification of Pigeon hole Rack

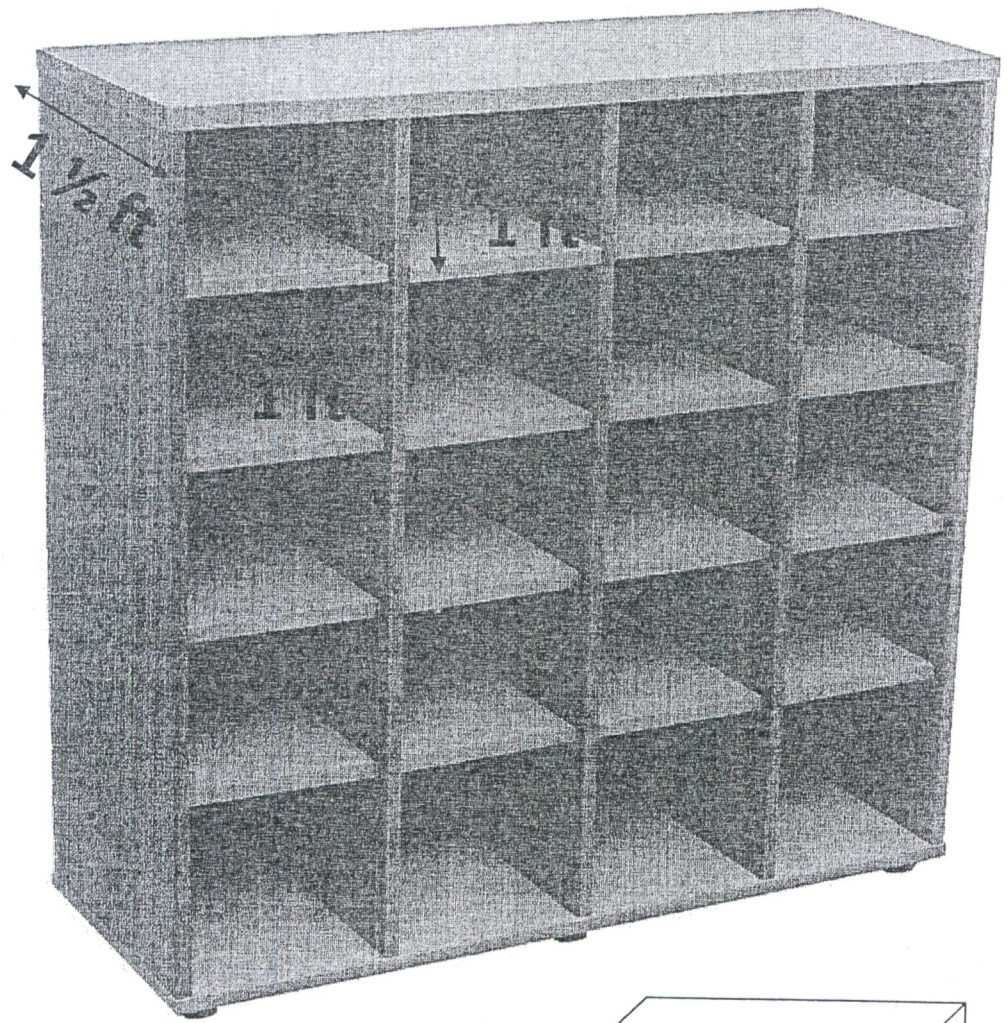

20 Holes

Material : Wooden or MDF

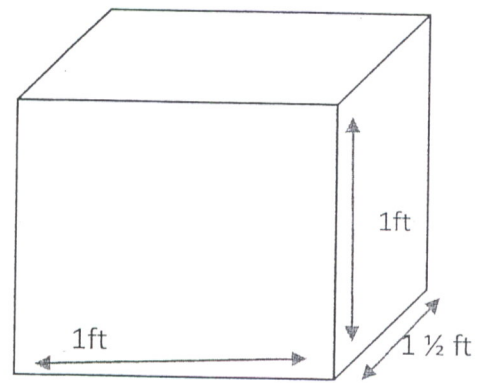

Hole Size

RLC

Eng(Dr.) RP Kumanayake
PhD(China), MBA(Colomb), MSc. Eng.(Moratuwa), AMIE(SL)
Head, Department of Mechanical Engineering
General Sir John Kotelawala Defence University
Ratmalana, Sri Lanka

SPECIMEN FORM OF BID SECURITY

By this Bond we (hereinafter called "the Bidder") and We (name of bank or insurance company) whose registered office is at (hereinafter called "the Surety") are held and firmly bound onto (hereinafter called the Authority") in the sum of for the payment of which sum the Bidder and the Surety bind themselves their successors and assigns jointly and severally by those presents.

Whereas the authority has invited the Tender and other persons to compete tenders in similar terms for the supply of and to submit the same for the consideration of the Authority, and the Bidder proposes to submit to the Authority a Bid (hereafter called "the Bid") in accordance with such invitation, the Bond shall provide security to the Authority that the Bidder will honour certain obligations to be undertaken by him in the Tender in accordance with the following conditions.

Now the Conditions of this Bond are:

- (a) That it shall remain in full force and effect until the earliest of
 - (i) (Date), being () days from (submission date), the date stipulated by the Authority for the submission of tenders, or any prolongation of such date above notified to the Authority by the Bidder and the Surety in writing.
 - (ii) In the event of acceptance of the Tender by the Authority, the date upon which the Bidder provides a performance security to the Authority in accordance with the terms of the contract thereby made between them, or
- (b) Subject to this Bond being in full force and effect, the Surety shall pay the full amount specified in this Bond upon receipt of first written demand form the Authority stating that.
 - (i) The Bidder has withdrawn his Tender during the validity of this Bond, or
 - (ii) The Bidder has failed to provide a performance security to the Authority in accordance with the terms of the tender within 14 days from receipt of intimation of award of the Tender.

No alteration in the terms of the Tender, nor any forbearance of forgiveness in or in respect of neither any matter or thing concerning the Tender on the part of the Authority, nor any objection from the bidder shall in any way release the Surety from any liability under this Bond.

The benefit of this Bond shall not be assignable by the Authority and upon its ceasing to be in full force and effect the Authority shall return the same to the Bidder.

This Bond shall be governed by the laws of Sri Lanka

I executed as a deed on this () day of () 20 ()

For and on behalf of the Bidder

Signed by -----

In the capacity of -----

and by -----

In the capacity of -----

Seal (where applicable)

For and on behalf of the Surety

Signed by -----

In the capacity of -----

and by -----

In the capacity of -----

Seal (where applicable)

DELIVERY SCHEDULE

(IT IS MANDATORY TO FILL THE FOLLOWING SCHEDULE BY THE BIDDER)

TENDER NO :

ITEM :

QTY :

DURATION	QTY
EX STOCK QTY (WITHIN 01 WEEK)	
01MONTH	
02 MONTHS	
03 MONTHS	
04 MONTHS	
TOTAL	

NAME OF THE BIDDER :

SIGNATURE OF BIDDER :

DATE :

COMPANY SEAL :